

ASB150PN series 150W

Smart battery charger

SMART & INTELLIGENT CHARGER



FEATURE

- Full range : 100VAC~240VAC
- LED Display Indicator
- Battery Recondition
- Fault Diagnostic
- Four - Stage Charging
- Over Charge Protection
- FAN For Micro-Control
- Error Code
- E-1 : Battery Type Error
- E-2 : Old Battery OR Bad Battery
- E-3 : Battery Polarity Reversal
- E-4 : Temperature Protection

CASE DRAWING

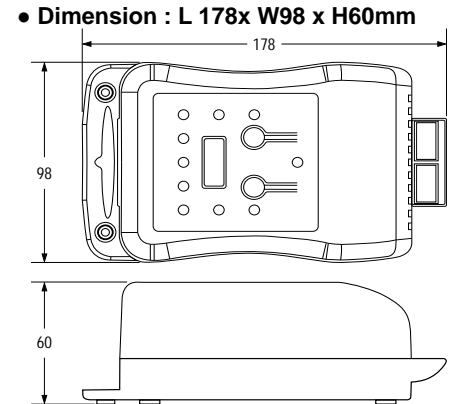

SPECIFICATION

MODEL NAME		ASB150PN-12V	ASB150PN-24V
Output	Charger voltage	REG/GEL/DEEP=14.5V / 14V / 15.3V	REG/AGM/GEL=29V / 29V / 28V
	Float voltage	13.6V	27.2V
	Charger range (A)	2A-10A	2A-5A
	Battery capacity	10A-200AH	10A-200AH
	Battery type	REG / AGM / GEL / DEEP	
	Battery leakage current	<1mA	
Input	Voltage range	90Vac ~ 264Vac	
	Frequency range	47Hz ~ 63Hz	
	Power factor (Typ.)	> 0.6 Full load	
	Efficiency (Typ.)	83%	
	AC current	4A / 110Vac, 2A / 220Vac	
	Inrush current (Typ.)	Cold start 40A / 110Vac, 80A / 220Vac	
	Leakage current	3.5mA / 220Vac	
Protection	Over voltage	> 20V Auto-recovery	
	Over temperature	> 105 °C, < 85°C recharger	
	Short circuit	Auto-recovery	
	Polarity reversal	Yes	
Environment	Operating temperature	0°C ~ +50°C	
	Operating humidity	20% ~ 85%	
	Storage temperature	-40°C ~ +85°C	
	Temp. coefficient	±0.03% / °C (0 ~ 50°C)	
	Vibration	10-500Hz, 2G 10min./1 cycle, 60min. each along X,Y,Z axes	
Safety & EMC	Safety standards	Meet UL1310 or UL1210	
	Withstand voltage	3000Vac 10mA for 60 seconds from primary to secondary	
	Isolation resistance	100 Mega ohms / 500Vac / 25°C / 70%	
	EMC emission	Complying to EN55022 (CISPR22); EN61000-3-2,-3	
	EMC immunity	Complying to EN61000-4-2,4,5	
On-off life	10,000 times repetition at 110Vac input		
Operation life	50,000 power-on hours at 25°C		
Dimension (L x W x H mm)	178 x 98 x 60mm (Case only)		
Charger weight (N.W.)	680g (Standard type)		

CABLE & CONNECTOR

- AC cable & AC plug(option)

* AC cable : UL SPT-2 18AWG x 2C

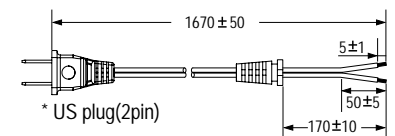

* AC cable : H0VVH2-F 2x0.75mm²

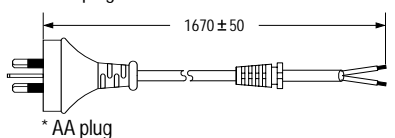
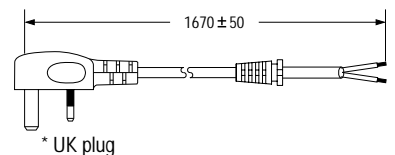
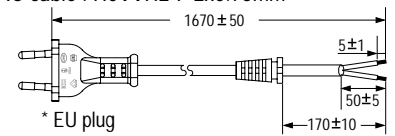

- Output cable & connector

* Output cable : UL SPT-2 16AWG x 2C , 2x1.31mm²

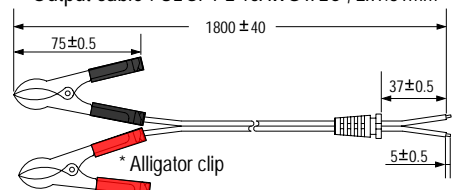

CHARING STEPS

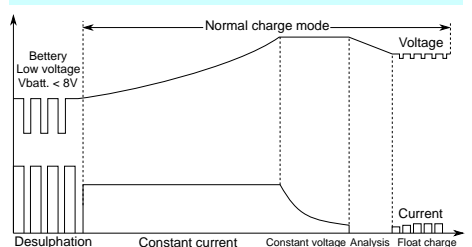

威海電子股份有限公司
WEIHAI POWER ELECTRONICS CO.,LTD.

6F. -6, No.700, Zhongheng Rd., Zhonghe Dist.,
New Taipei City 235, Taiwan (R.O.C.)
TEL: 886-2-82273718 FAX: 886-2-82273719
E-MAIL: sales@wpe.com.tw